

ADI SOYADI:

5.HAFTA

TÜRKÇE

1.SINIF TEMEL DERSLER ÇALIŞMA KAĞIDI

Varlıkların adlarını söyleyelim. Adında "t" sesi olan varlıkları boyayalım.

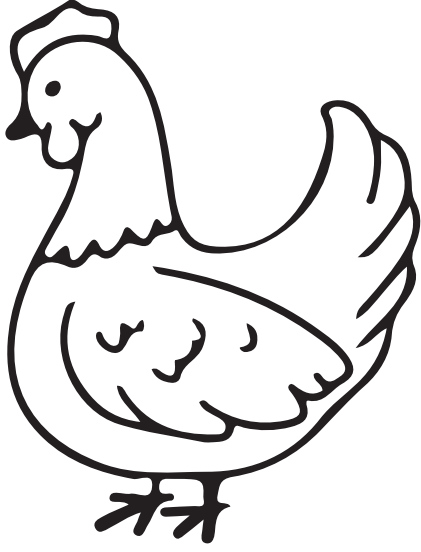

Tavuk

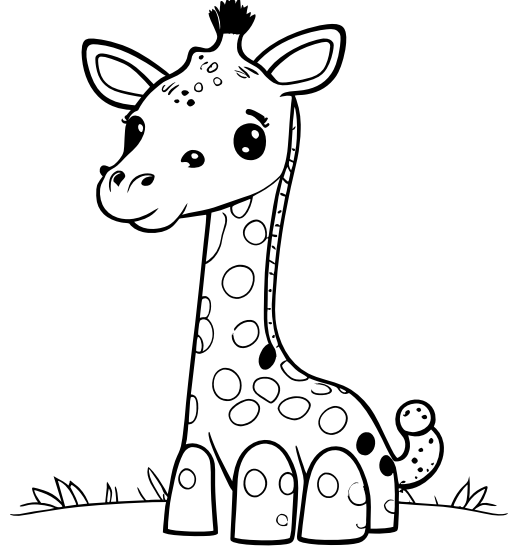

Zürafa



Tavşan

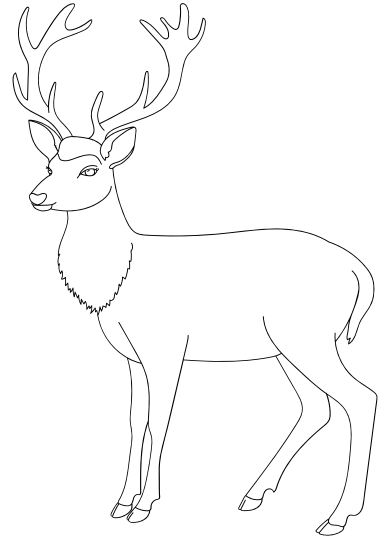

Geyik

ADI SOYADI:

5.HAFTA

TÜRKÇE

1.SINIF TEMEL DERSLER ÇALIŞMA KAĞIDI



"t" ve "T" harflerini ok yönünde numaralara göre boyayalım.
Varlıkların adındaki e seslerini yuvarlak içine alalım.

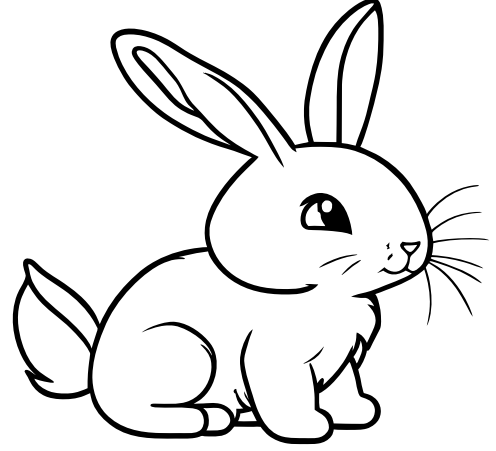
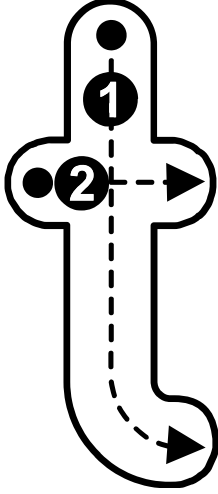

tavşan

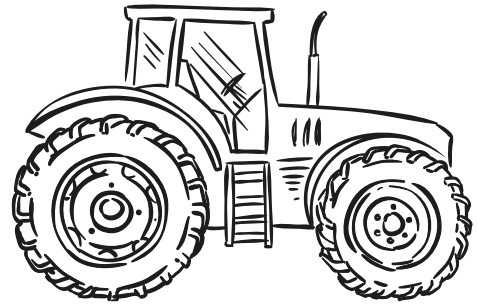
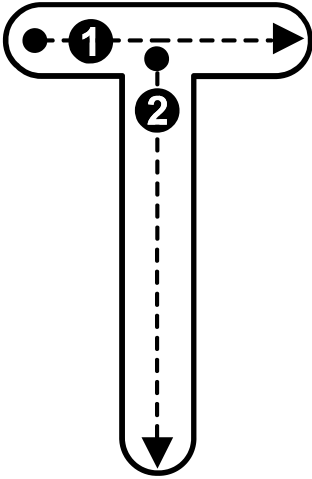

Traktör

ADI SOYADI:

5.HAFTA

TÜRKÇE

1.SINIF TEMEL DERSLER ÇALIŞMA KAĞIDI

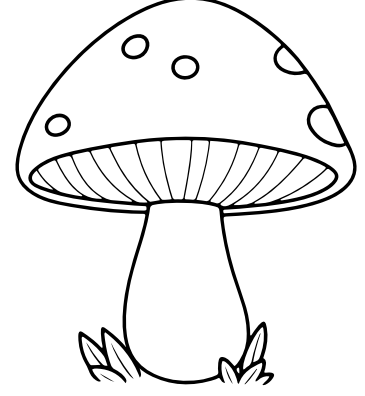
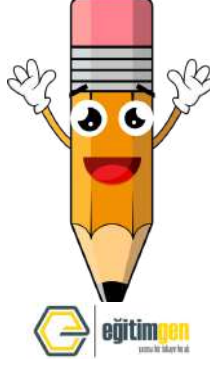
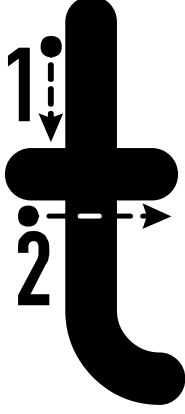

Mantar



“t” harflerindeki noktaları birleştirelim ve yazalım.

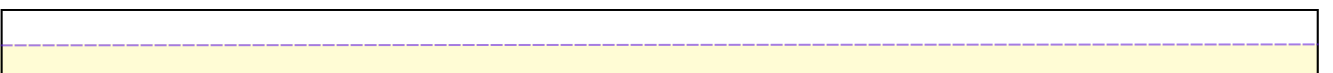
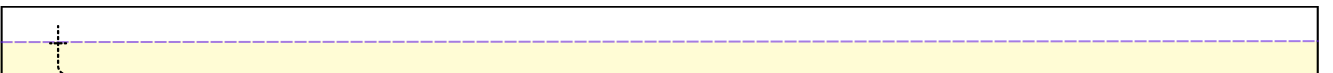
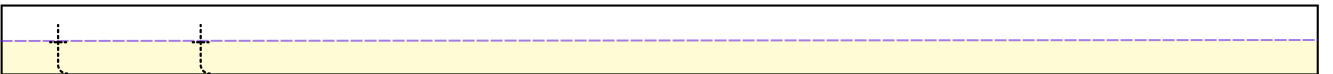

ADI SOYADI:

5.HAFTA

TÜRKÇE

1.SINIF TEMEL DERSLER ÇALIŞMA KAĞIDI

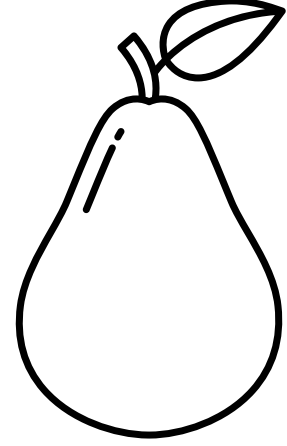
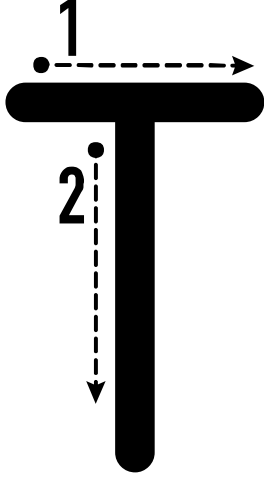

Armut



"T" harflerindeki noktaları birleştirelim ve yazalım.

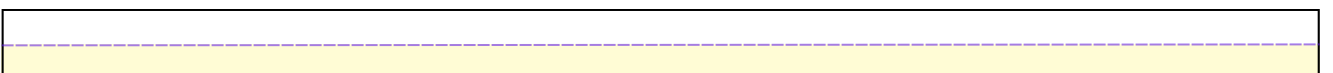
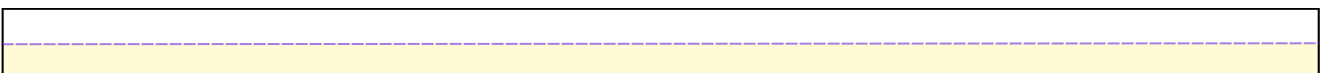
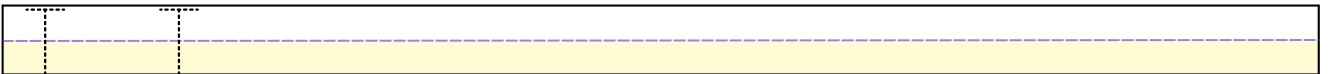
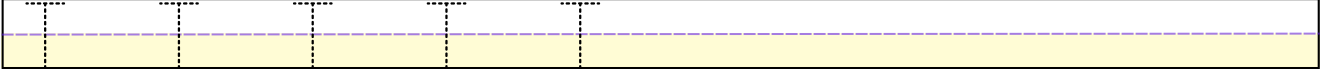

ADI SOYADI:

5.HAFTA

TÜRKÇE

1.SINIF TEMEL DERSLER ÇALIŞMA KAĞIDI

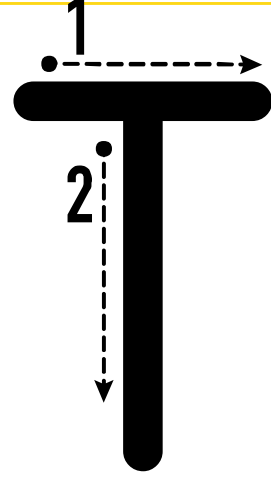
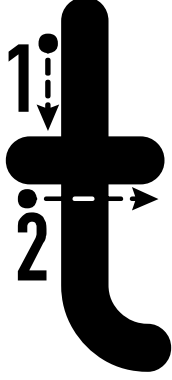

“t ve T” harflerindeki noktaları birleştirelim ve yazalım.

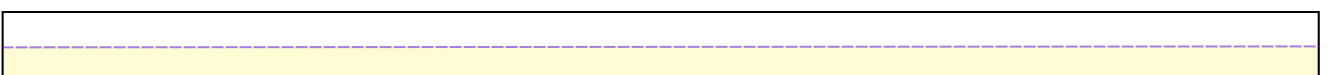
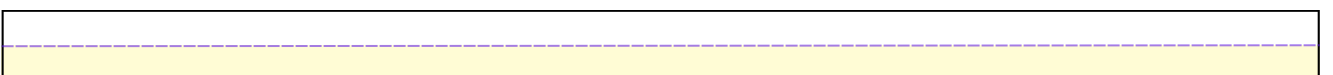
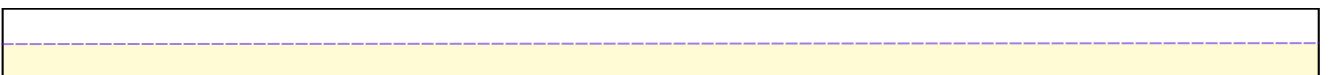
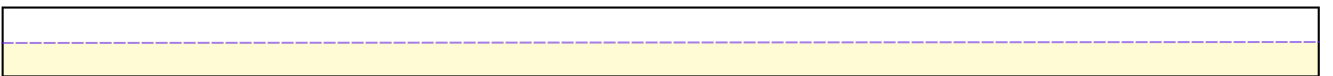
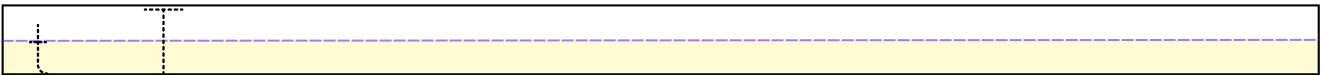
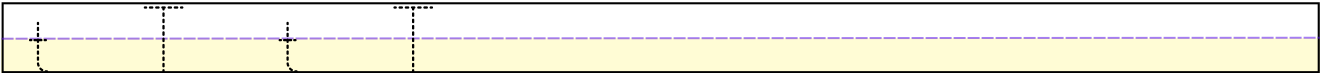
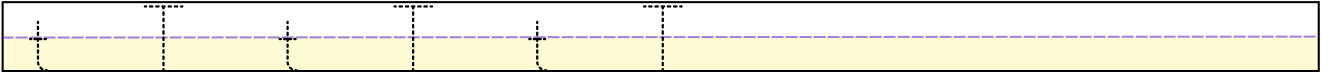
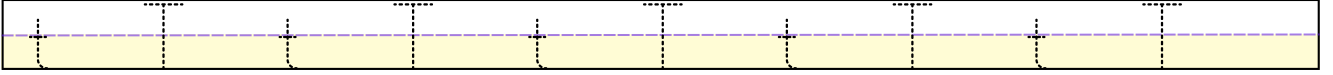

ADI SOYADI:

5.HAFTA

TÜRKÇE

1.SINIF TEMEL DERSLER ÇALIŞMA KAĞIDI



Aşağıdaki hece ve kelimeleri okuyup yazalım.

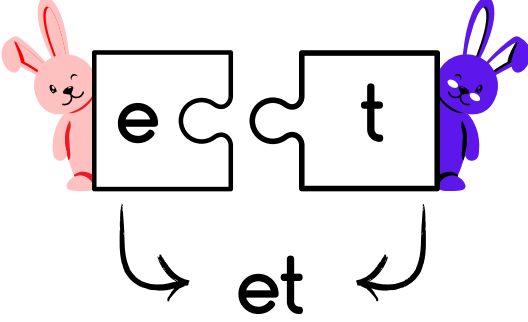

et

et

et

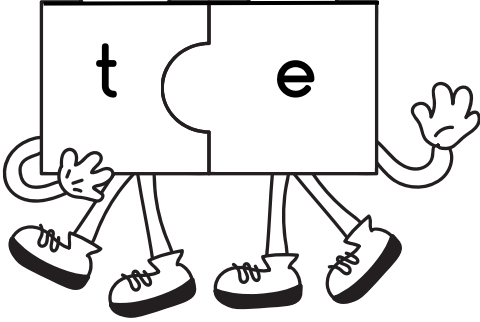

te

te

te

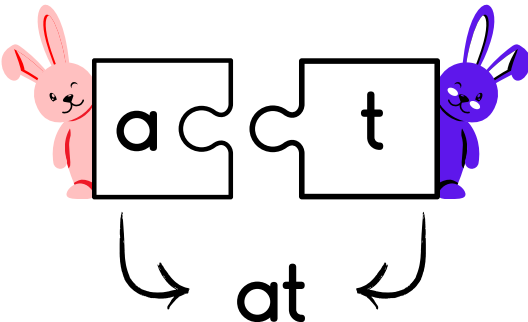

at

at

at

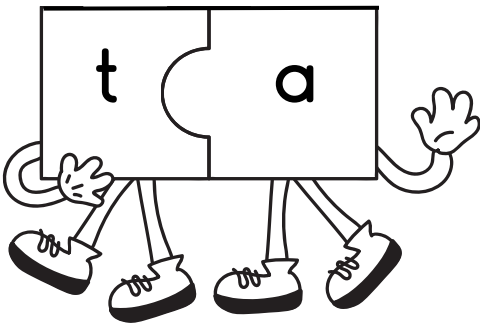

ta

ta

ta

ADI SOYADI:

5.HAFTA

TÜRKÇE

1.SINIF TEMEL DERSLER ÇALIŞMA KAĞIDI



Aşağıdaki hece ve kelimeleri okuyup yazalım.

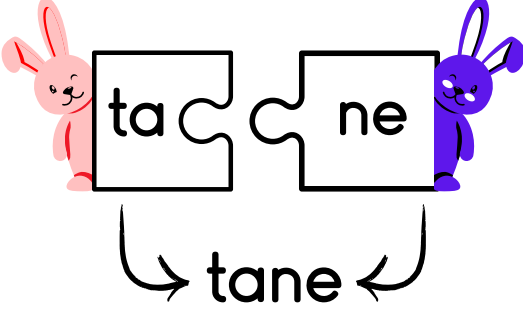

tane

tane

tane

tane

tane

tane

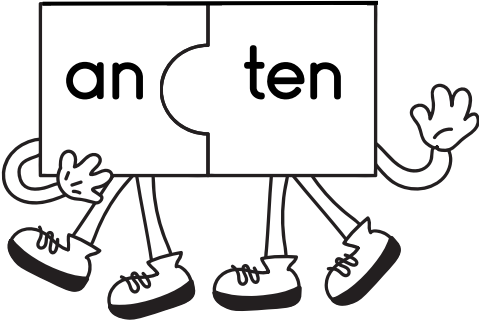

anten

anten

anten

anten

anten

anten

anten

ADI SOYADI:

5.HAFTA

MATEMATİK

1.SINIF TEMEL DERSLER ÇALIŞMA KAĞIDI

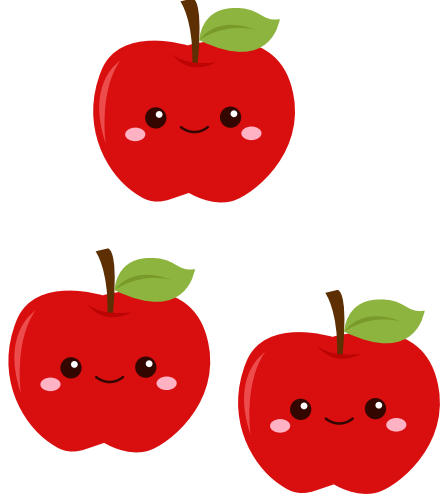
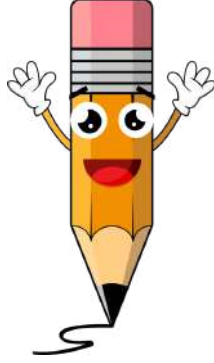

“3” Rakamındaki noktaları birleştirelim ve yazalım.

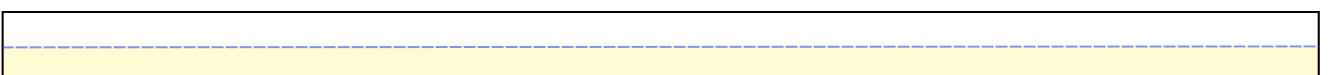
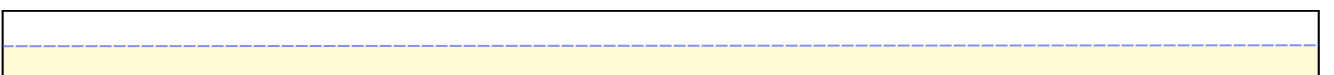
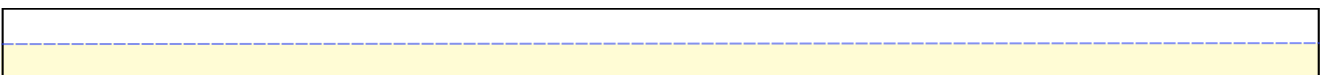
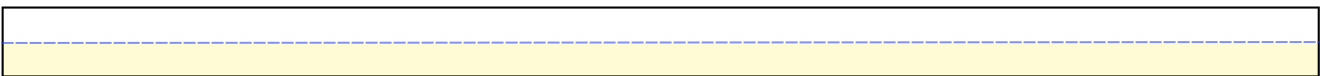

ADI SOYADI:

5.HAFTA

MATEMATİK

1.SINIF TEMEL DERSLER ÇALIŞMA KAĞIDI

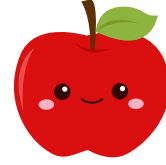
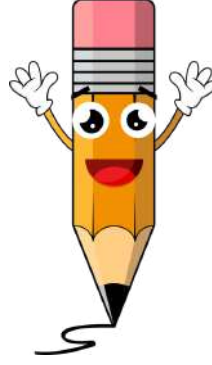
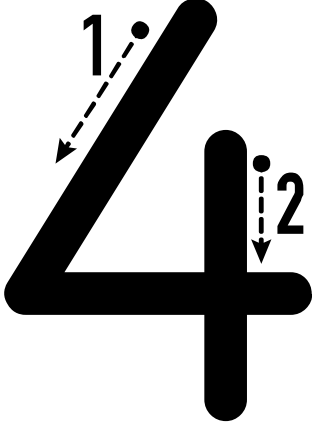

“4” Rakamındaki noktaları birleştirelim ve yazalım.

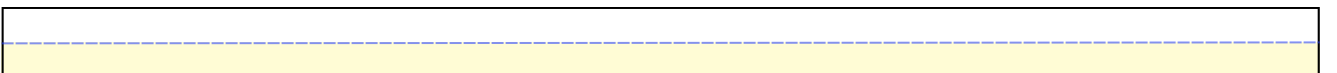
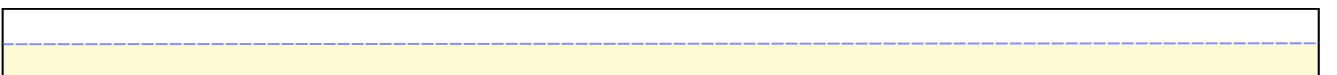
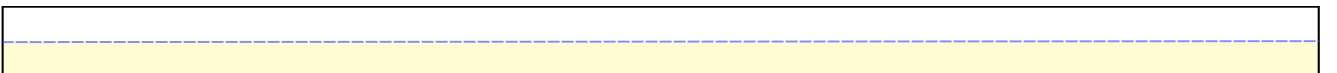
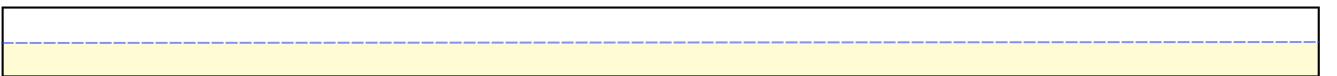
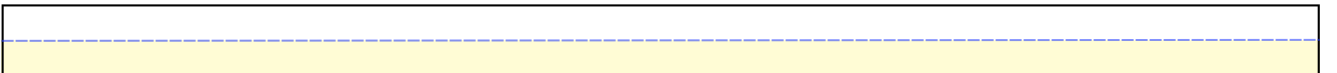
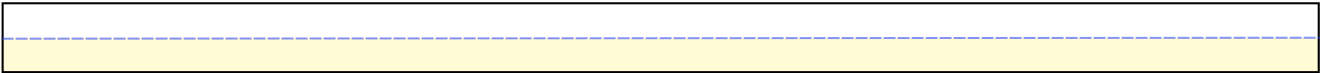
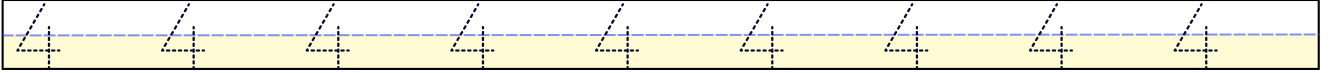

ADI SOYADI:

5.HAFTA

HAYAT BİLGİSİ

1.SINIF TEMEL DERSLER ÇALIŞMA KAĞIDI



Aşağıdaki görsellerden sınıf kuralına uymayan görselleri işaretleyelim.



Okul çalışanlarının isimlerini uygun görselle eşleştirelim.



öğretmen



hizmetli



müdür yardımcısı



müdür